

# Organigrama

## ESTRUCTURA ORGÁNICA

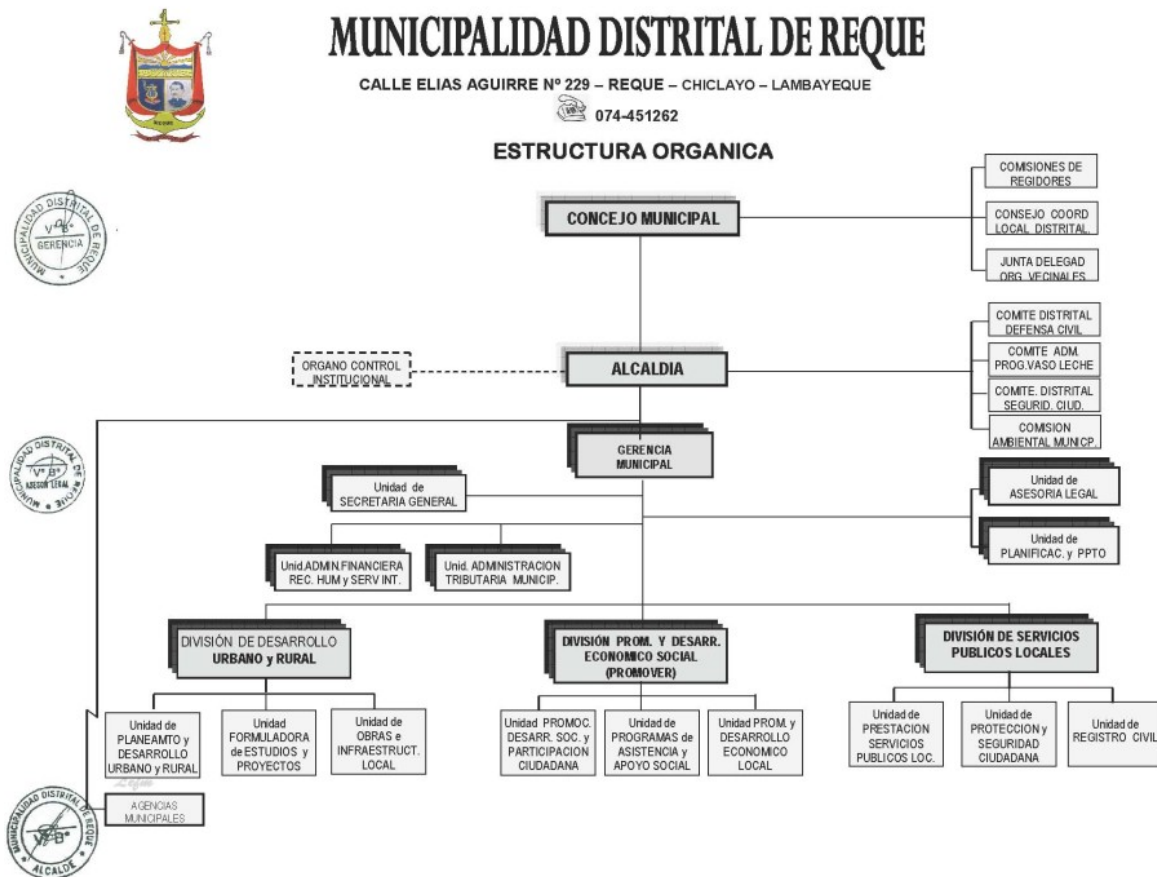

## ORGANIGRAMA ALTA DIRECCIÓN



# MUNICIPALIDAD DISTRITAL DE REQUE

CALLE ELIAS AGUIRRE N° 229 – REQUE – CHICLAYO – LAMBAYEQUE

074-451262

## ORGANOS NORMATIVOS Y DE FISCALIZACION

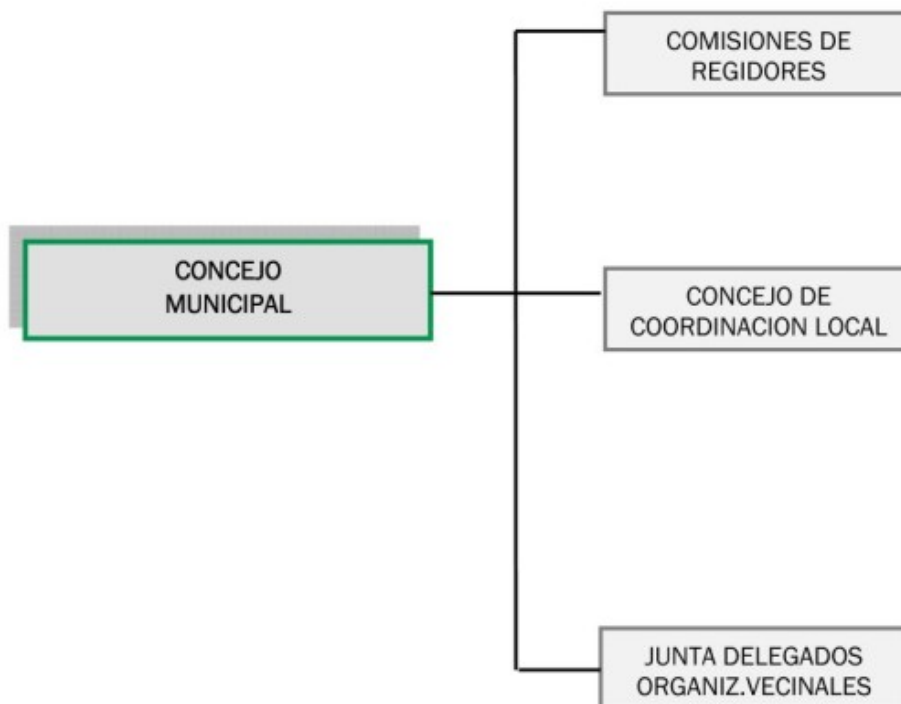



# MUNICIPALIDAD DISTRITAL DE REQUE

CALLE ELIAS AGUIRRE N° 229 – REQUE – CHICLAYO – LAMBAYEQUE

074-451262

## ORGANOS CONSULTIVOS, DE COORDINACION, CONCERTACION Y PARTICIPACION

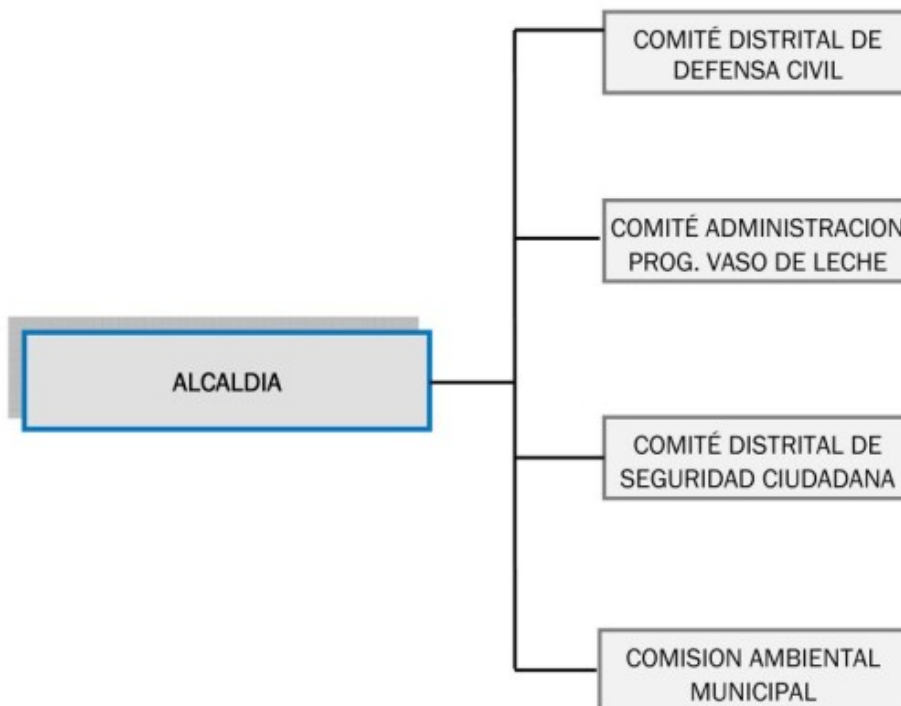

## **ORGANIGRAMA ÓRGANOS DE ASESORAMIENTO**



# MUNICIPALIDAD DISTRITAL DE REQUE

CALLE ELIAS AGUIRRE N° 229 – REQUE – CHICLAYO – LAMBAYEQUE

 074-451262

## ORGANOS DE ASESORAMIENTO

### UNIDAD DE ASESORIA LEGAL





# MUNICIPALIDAD DISTRITAL DE REQUE

CALLE ELIAS AGUIRRE N° 229 – REQUE – CHICLAYO – LAMBAYEQUE

074-451262

## UNIDAD DE PLANIFICACION Y PRESUPUESTO



GERENCIA MUNICIPAL

UNIDAD DE PLANIFICACION Y PRESUPUESTO



AREA DE PLANEAMIENTO ESTRATEGICO

AREA DE PROGRAMACION Y EVALUACION PRESUPUESTARIA

AREA DE PROGRAMACION DE INVERSIONES Y COOPERACION TECNICA

AREA DE RACIONALIZACION y ESTADISTICA





# MUNICIPALIDAD DISTRITAL DE REQUE

CALLE ELIAS AGUIRRE N° 229 – REQUE – CHICLAYO – LAMBAYEQUE

074-451262

## ORGANOS DE APOYO

### UNIDAD DE SECRETARIA GENERAL

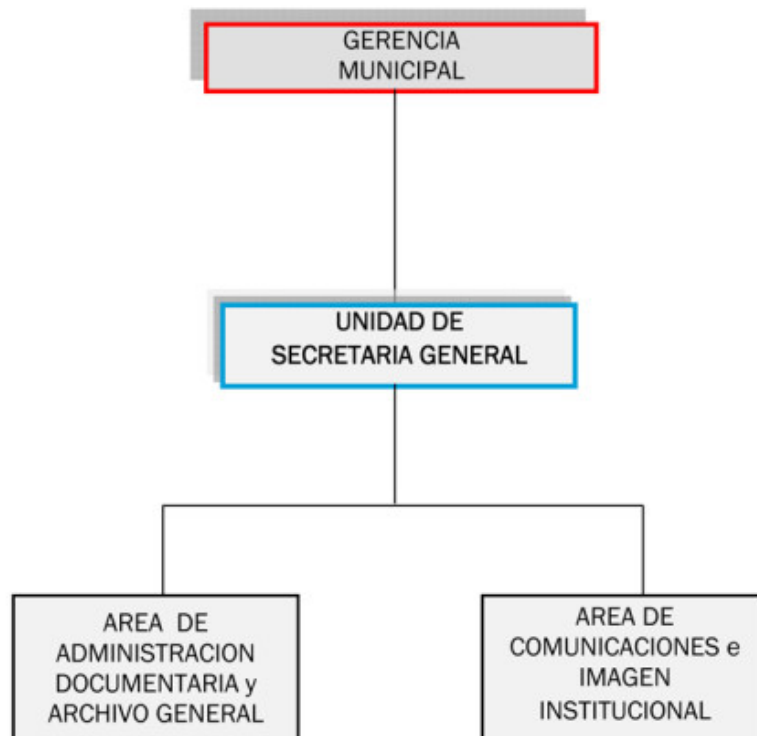



# MUNICIPALIDAD DISTRITAL DE REQUE

CALLE ELIAS AGUIRRE N° 229 – REQUE – CHICLAYO – LAMBAYEQUE

074-451262

## UNIDAD DE ADMINISTRACION FINANCIERA, RECURSOS HUMANOS y SERVICIOS INTERNOS

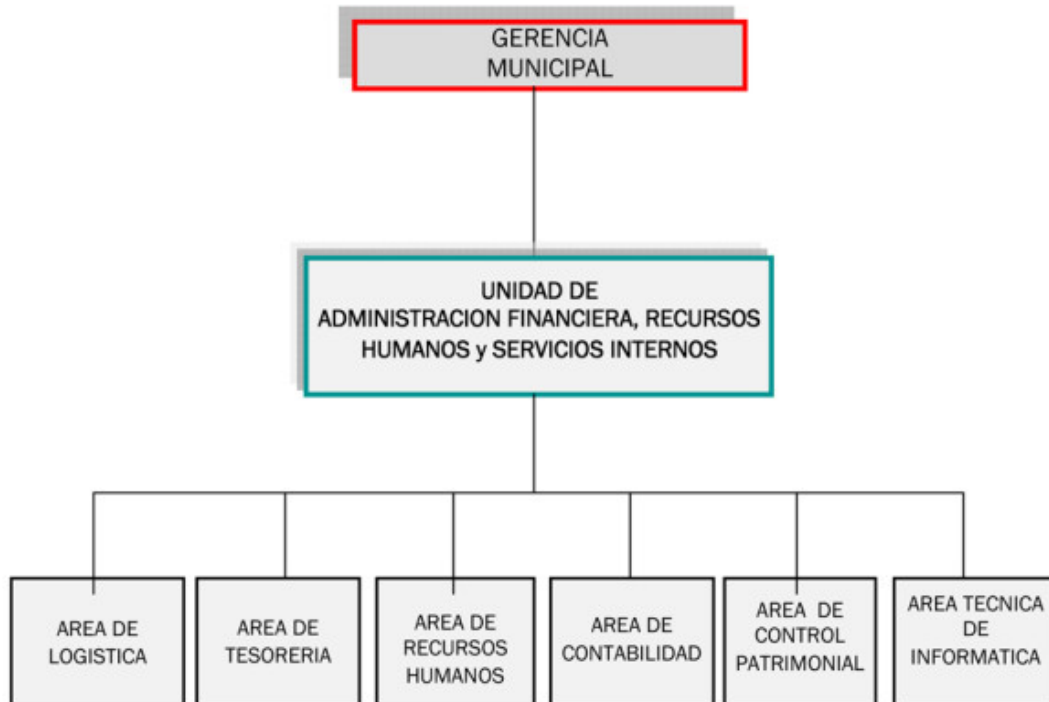





# MUNICIPALIDAD DISTRITAL DE REQUE

CALLE ELIAS AGUIRRE N° 229 – REQUE – CHICLAYO – LAMBAYEQUE

074-451262

## UNIDAD DE ADMINISTRACION TRIBUTARIA MUNICIPAL

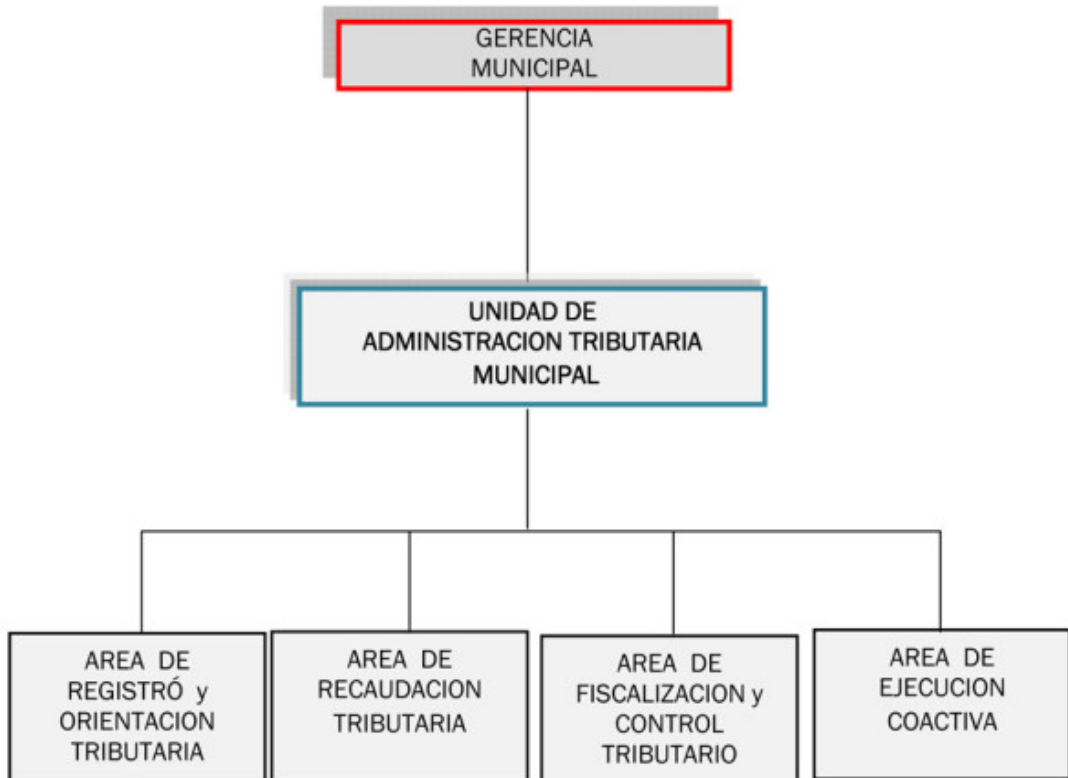



# MUNICIPALIDAD DISTRITAL DE REQUE

CALLE ELIAS AGUIRRE N° 229 – REQUE – CHICLAYO – LAMBAYEQUE

074-451262

## ORGANOS DE LINEA

### DIVISION DE DESARROLLO URBANO y RURAL

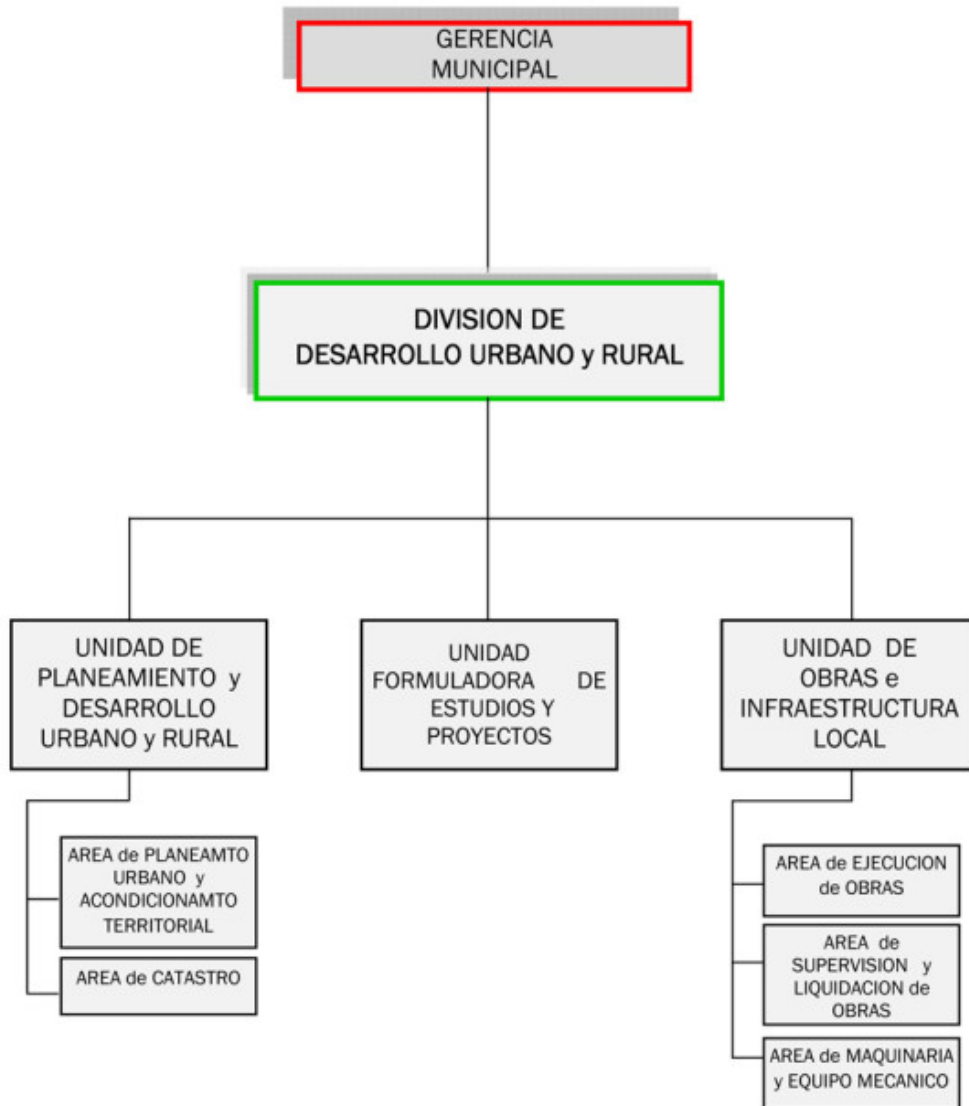



# MUNICIPALIDAD DISTRITAL DE REQUE

CALLE ELIAS AGUIRRE N° 229 – REQUE – CHICLAYO – LAMBAYEQUE

074-451262

DIVISION DE PROMOCION y DESARROLLO ECONOMICO SOCIAL PROMOVER





# MUNICIPALIDAD DISTRITAL DE REQUE

CALLE ELIAS AGUIRRE N° 229 – REQUE – CHICLAYO – LAMBAYEQUE

074-451262

## DIVISION DE SERVICIOS PUBLICOS LOCALES

